



DIESEL • MAZOUT • GASOIL
500 - 2900 LTRS

Vlarem II
kiwa
Partner for progress
ADR



Vlarem II
kiwa
Partner for progress

REGISTERED FIRM
BM TRADA
CERTIFICATION
ISO 9001:2000

UKAS
QUALITY
MANAGEMENT
012

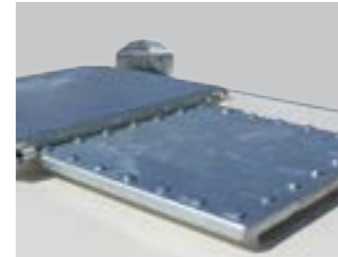
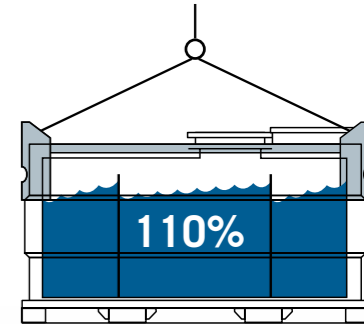
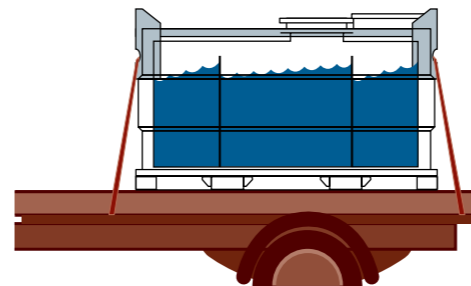

5 NIJVERHEIDSTRAAT, 1830 MACHELEN, BELGIUM.

+32 (0)2 460 36 59 +32 (0)2 461 36 22 +32 (0)473 82 61 71

info@delmat.be www.delmat.be



05TCG 465 LTRS



10TCG 910 LTRS







20TCG 2000 LTRS

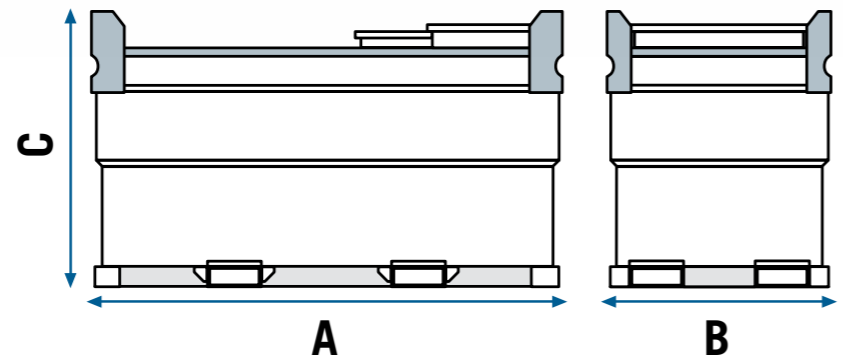

30TCG 2900 LTRS



			A ↔	B ↔	C ↑	 Kgs	 Kgs
05TCG	465 LTRS		1150	1150	838	437	862
10TCG	910 LTRS		1150	1150	1320	484	1377
20TCG	2000 LTRS		2300	1150	1320	865	2665
30TCG	2900 LTRS		2300	1550	1320	992	3692



TP30DM | 155 LITRE



TP50DM | 253 LITRE



TP90DM | 435 LITRE



EH12VFPF: 12v 70 L/M
EB24VFPF: 24V 70 L/M



CONSTRUX: H40 L/M

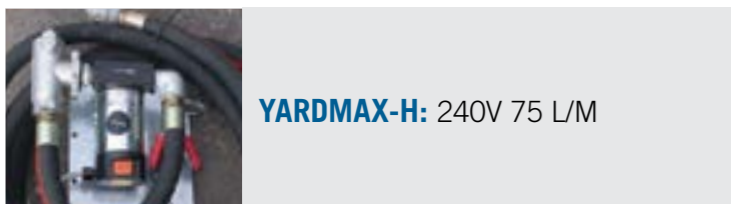

YARDMAX-H: 240V 75 L/M

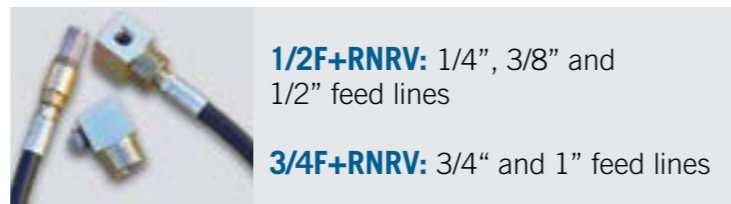

1/2F+RNRV: 1/4", 3/8" and 1/2" feed lines
3/4F+RNRV: 3/4" and 1" feed lines

